



# CXv4, a Modular Control System

Dmitry Bolkhovityanov, Fedor Emanov, Pavel Cheblakov  
 Budker Institute of Nuclear Physics, Novosibirsk, Russia



## CX

- Developed in BINP since late 1990s
- Runs on Linux and \*NIX
- Supported hardware includes CAMAC, PCI/cPCI, VME, CAN, RS485
- Used at VEPP-5, LIA-2 and several smaller facilities

## VEPP-5 Injection Complex

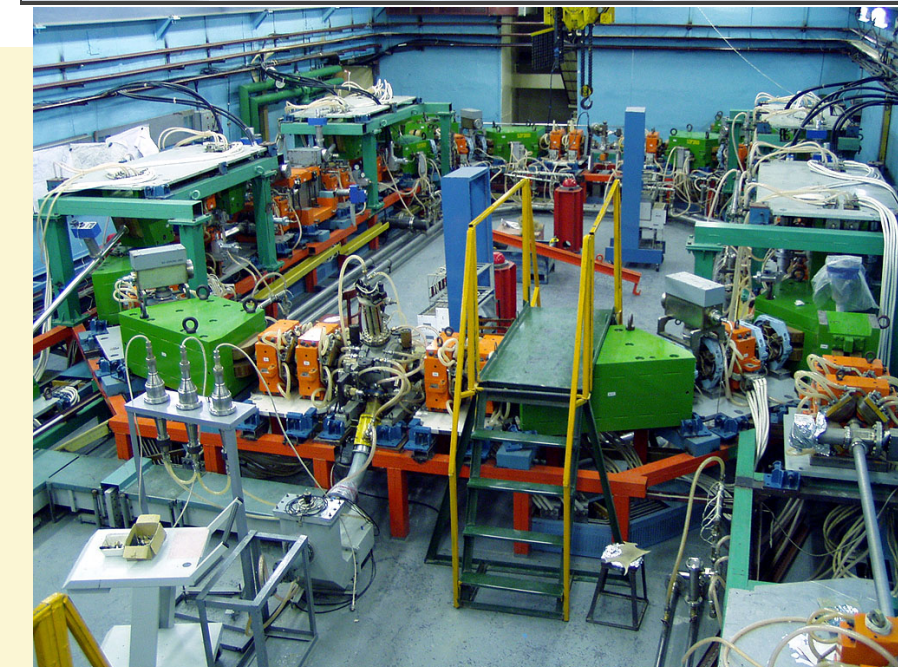
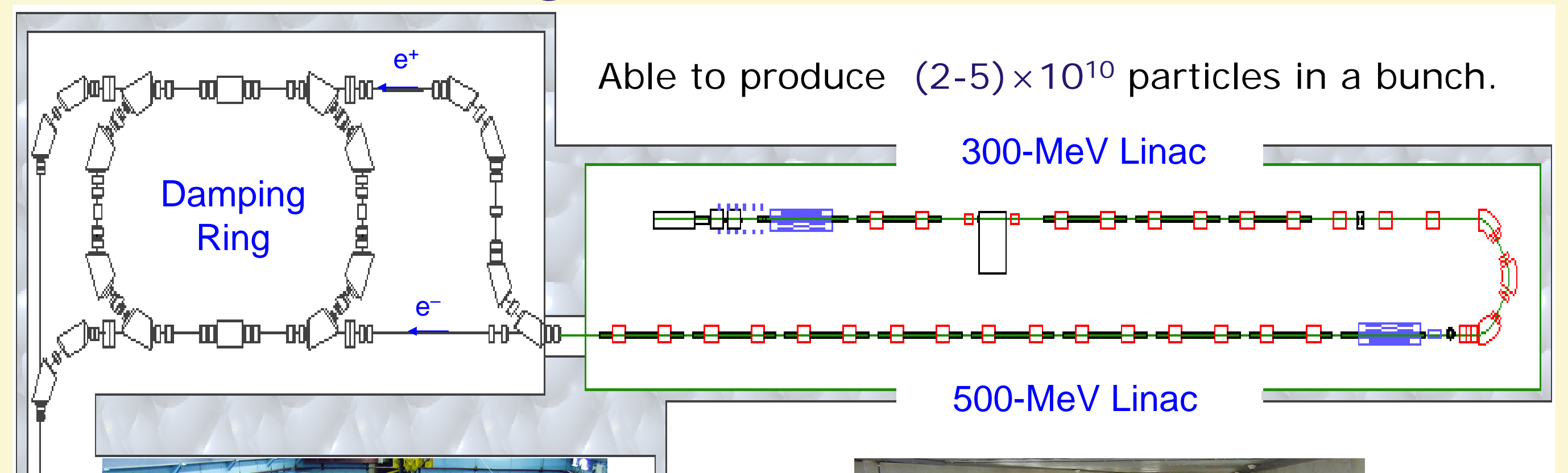

VEPP-5 will supply e+ and e- to BINP e+/e- colliders VEPP-4 and VEPP-2000. Thus, communication with their diverse control systems is required in CX. **HOW?**

**Solution:** make *everything* modular.

- Drivers, network protocol implementation (at both client and server sides) are plugins.
- Server is a library.

## Conventional 3-layer control system layout

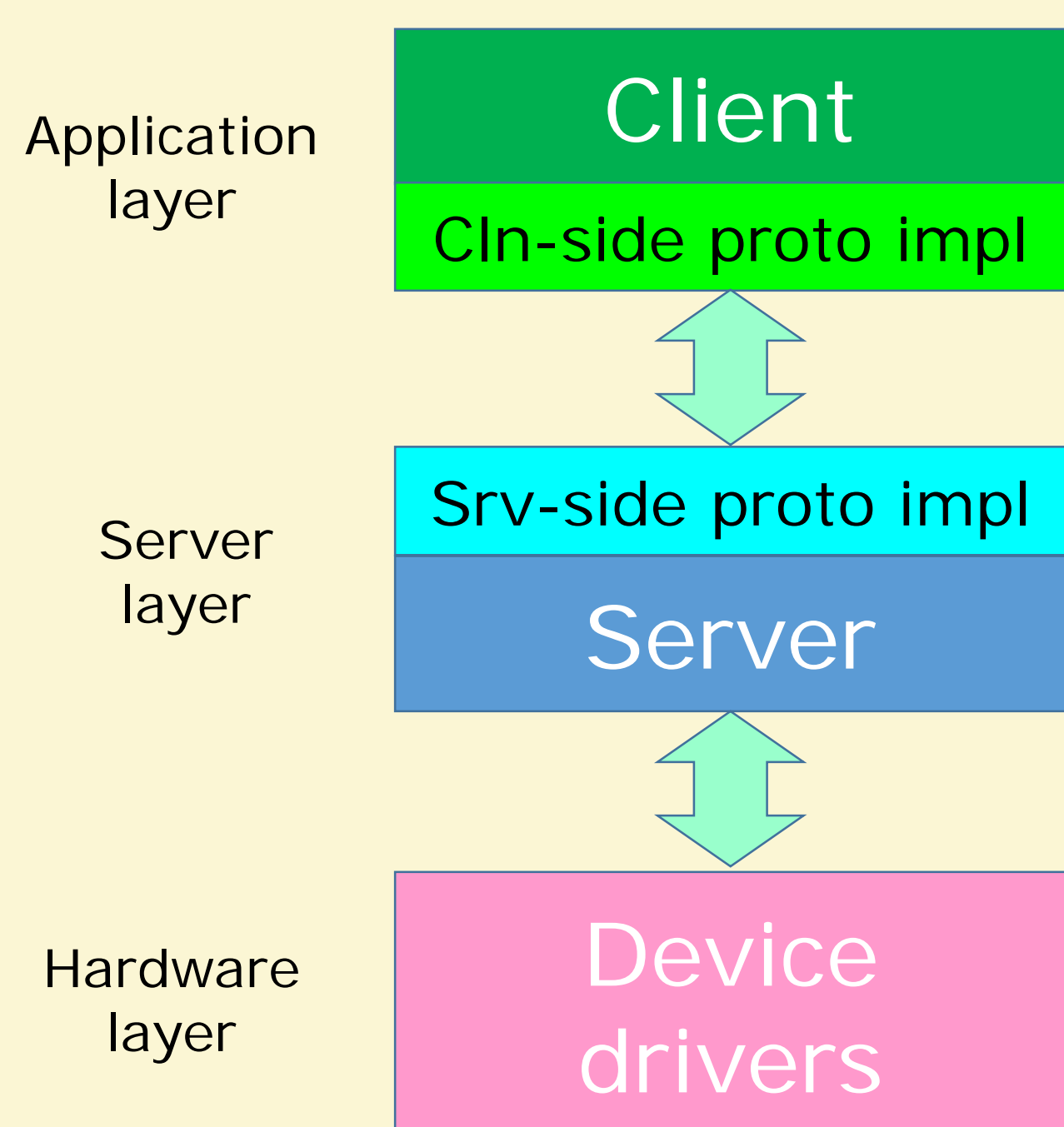

## CXv4 modular structure

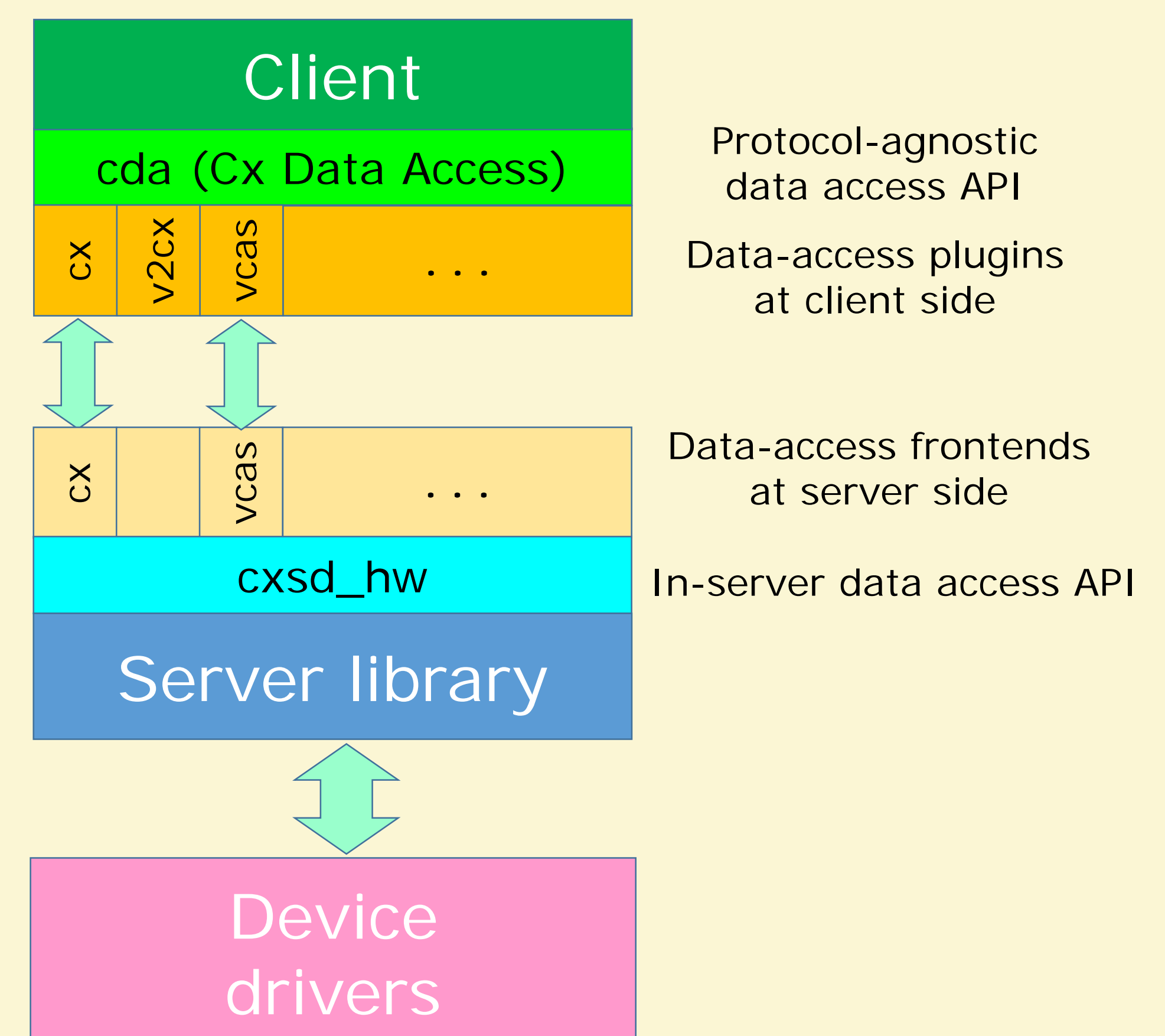

## Possible combinations of CX modules

"insrv" is a null-link plugin, providing CDA access to server's channels from inside of the server process

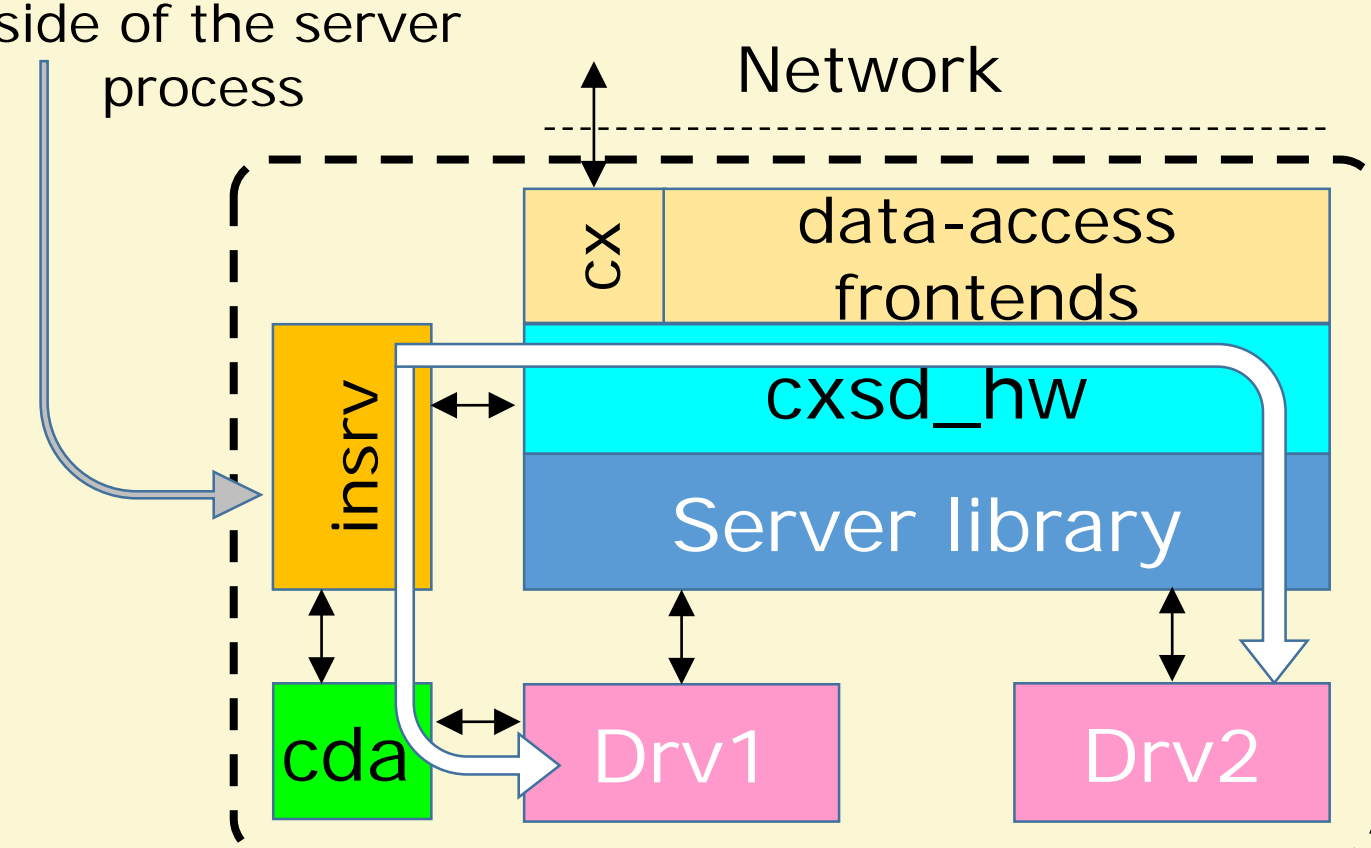

Drivers can access channels from neighbor drivers like clients.

Unified API for local and remote.

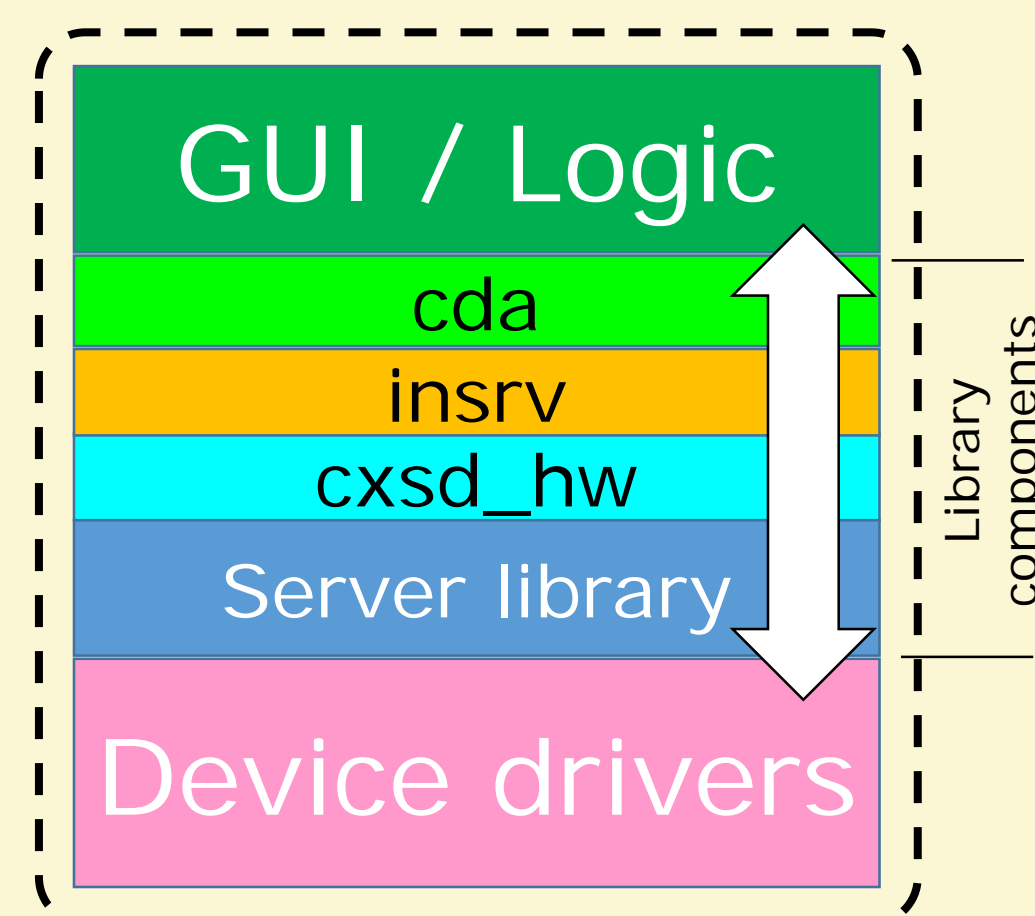

GUI+server+drivers combined into a single simple application with no network

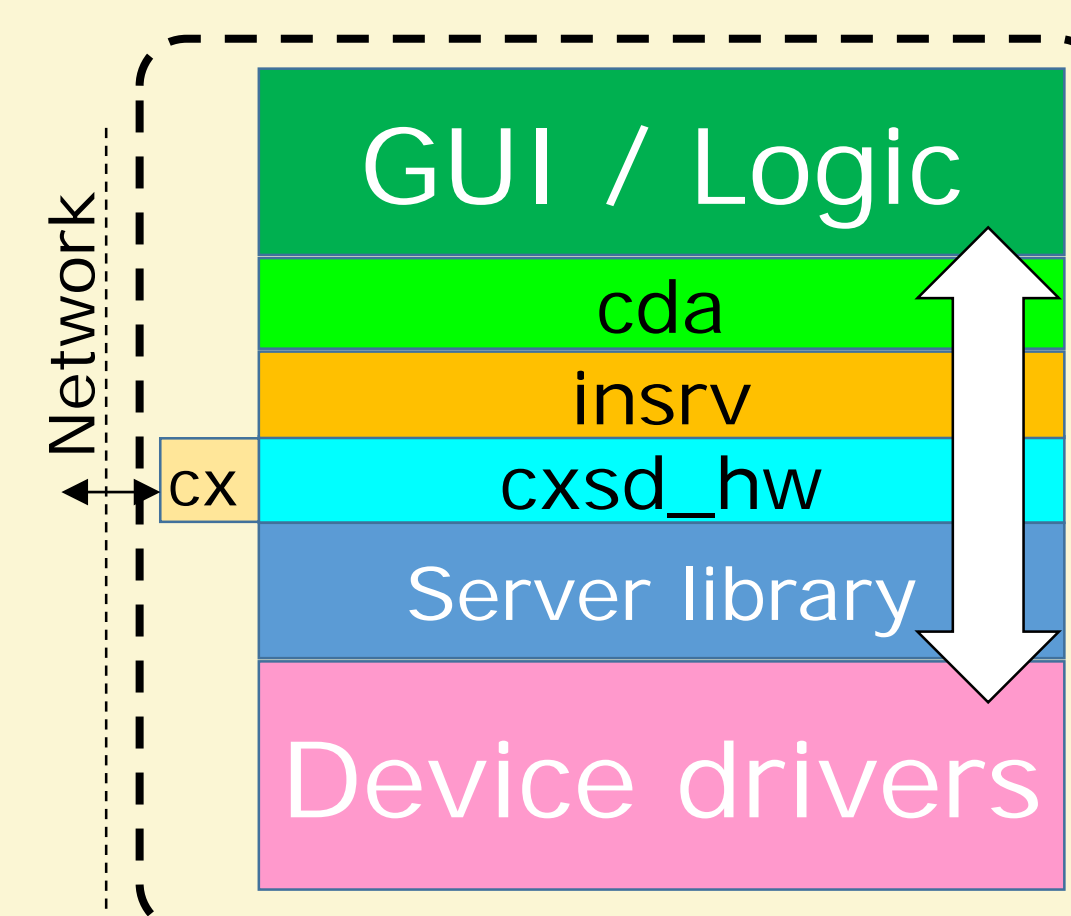

GUI+server+drivers combined into a single simple application with remote access

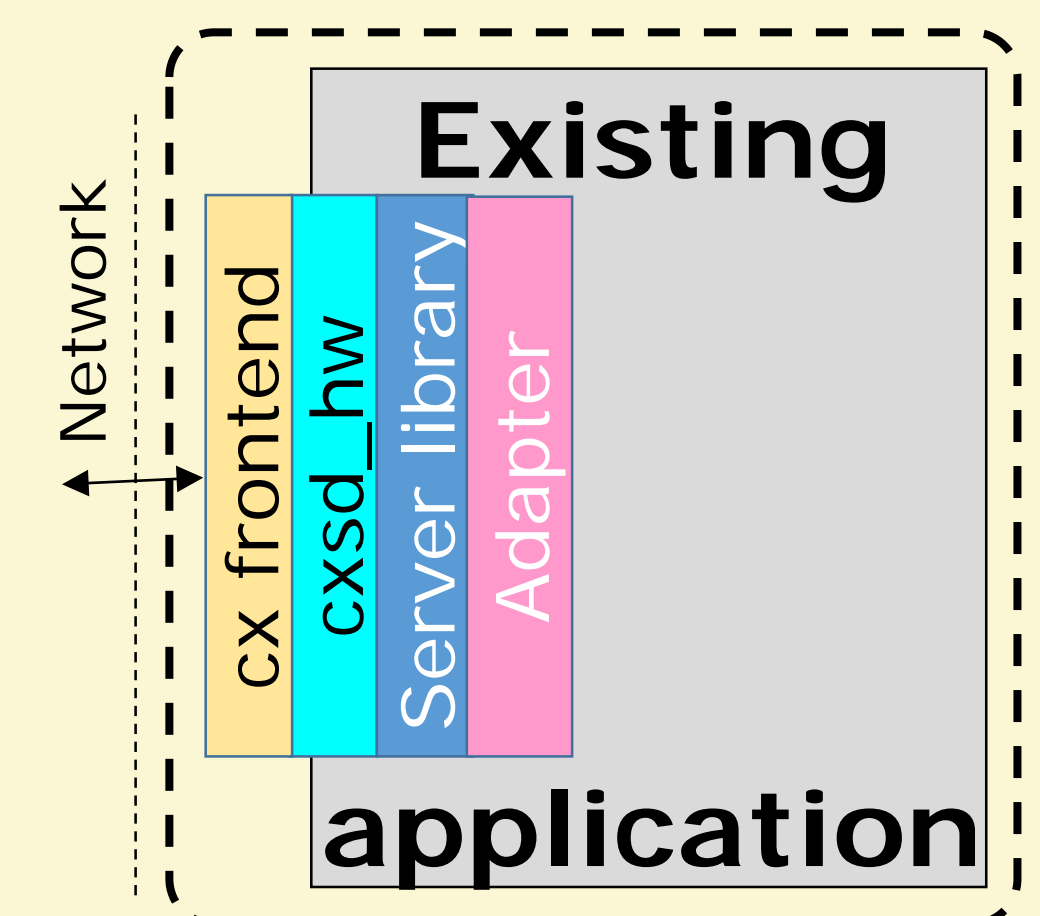

Network-access-enabled existing application